



# EXPRESSIONS™ SERIES

## Price Book

Prices Effective  
February 2, 2024



### Yale Expressions™ Series - Exclusive to EMTEK Dealers

- All **EMTEK** Dealers have access to Yale Expressions™ automatically
- Freight prepaid with no minimum order requirements
- Order Yale Expressions™ and **EMTEK** products on the same purchase order
- Same **EMTEK** Sales Representative and Customer Service team
- Not available in Big Box stores or their websites



# Trusted every day

Yale Home has provided dependable security since 1840. We offer a broad spectrum of door hardware and locks including an extensive range of residential hardware options. Yale Home protects millions of homes and businesses worldwide and is the brand behind locks of every design and function in over 125 countries.

As one of the oldest international security brands, Yale Home is among the best-known and most respected names in the lock industry. The company is a proud supporter of Habitat for Humanity, and has provided more than 700,000 locks to Habitat for Humanity homes.

For more information, visit [YaleExpressions.com](https://YaleExpressions.com) or [YaleHome.com](https://YaleHome.com).



**Yale Expressions™** is a collection of door hardware that offers homeowners an elevated look at an affordable price.

- Designed to meet Grade 3 standards for value and security
- Removable cylinder for ease of re-keying without special tools
- Non-handed levers lower inventory needs, minimize mistakes
- Adjustable latches take out the guesswork
- 3 keyway options: Schlage (SC1), Kwikset (KW1) and Weiser (WR5)
- Lifetime mechanical / 5 year finish warranty

## CONTENTS

---

<b>Lever &amp; Knob Options</b>	4
<b>Finishes</b>	5
<b>General Information</b>	6
<b>By Collection</b>	
Marcel - Modern	8
Ellington - Transitional	10
Everly - Traditional	12
Maguire - Traditional	14
<b>By Function</b>	
Entry Sets - Complete	16
Entry Sets - Exterior	20
Entry Sets - Interior	21
Entry Sets - Upgrade	25
Deadbolts	27
Keyed Levers	28
Keyed Knobs	30
Passage & Privacy Levers	32
Passage & Privacy Knobs	34
Barn Door Flat Track Hardware Kit	36
Pocket Door Locks	39
<b>Accessories</b>	40
<b>Technical Specifications</b>	43
<b>Displays</b>	46
<b>Warranty</b>	47

**Nils**  
Lever



Marcel Rosette



Owen Rosette

**Holden**  
Lever

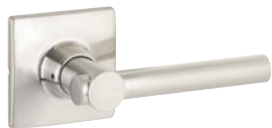

Marcel Rosette



Owen Rosette

**Brunswick**  
Lever



Ellington Rosette



Maguire Rosette



Owen Rosette

**Farmington**  
Lever



Everly Rosette



Maguire Rosette

**Dylan**  
Knob



Marcel Rosette



Owen Rosette

**Walker**  
Knob



Ellington Rosette



Maguire Rosette



Owen Rosette

**Auburn**  
Knob



Everly Rosette



Maguire Rosette

**Lewiston**  
Knob



Everly Rosette



Maguire Rosette

# FINISHES

		PAGES	US3	US4	US10B	US15	US19	US26
<b>LEVERS</b>								
MODERN	Nils Lever with Marcel Rosette	9, 17, 21, 28, 32		●		●	●	●
	Nils Lever with Owen Rosette	21, 29, 33		●		●	●	●
	Holden Lever with Marcel Rosette	9, 17, 21, 28, 32		●		●	●	●
	Holden Lever with Owen Rosette	21, 29, 33		●		●	●	●
TRANSITIONAL	Brunswick Lever with Ellington Rosette	11, 17, 22, 29, 33			●	●	●	●
	Brunswick Lever with Maguire Rosette	22, 29, 33			●	●	●	●
	Brunswick Lever with Owen Rosette	21, 29, 33			●	●	●	●
TRADITIONAL	Farmington Lever with Everly Rosette	13, 18, 22, 29, 33	●		●	●		●
	Farmington Lever with Maguire Rosette	15, 18, 23, 29, 33	●		●	●		●

		PAGES	US3	US4	US10B	US15	US19	US26
<b>KNOBS</b>								
MODERN	Dylan Knob with Marcel Rosette	9, 18, 23, 30, 34		●		●	●	●
	Dylan Knob with Owen Rosette	23, 30, 34		●		●	●	●
TRANSITIONAL	Walker Knob with Ellington Rosette	11, 19, 23, 31, 35			●	●	●	●
	Walker Knob with Maguire Rosette	24, 31, 35			●	●	●	●
	Walker Knob with Owen Rosette	23, 31, 35			●	●	●	●
TRADITIONAL	Auburn Knob with Everly Rosette	13, 19, 24, 31, 35	●		●	●		●
	Auburn Knob with Maguire Rosette	15, 19, 24, 31, 35	●		●	●		●
	Lewiston Knob with Everly Rosette	13, 19, 24, 31, 35	●		●	●		●
	Lewiston Knob with Maguire Rosette	15, 19, 24, 31, 35	●		●	●		●



**Polished Brass**  
US3



**Satin Brass**  
US4



**Oil Rubbed Bronze**  
US10B



**Satin Nickel**  
US15



**Flat Black**  
US19



**Polished Chrome**  
US26

**ORDERING AND RETURNS****Placing Orders**

You have several options to place an order:

- Email: [orders@emtek.com](mailto:orders@emtek.com)
- Fax: 800-577-5771
- Phone: 800-356-2741
- Online: [webshop.emtek.com](http://webshop.emtek.com)

**Hours of Operation**

Monday – Friday: 5:00 AM - 5:00 PM Pacific Time.

**Minimum Order Requirements**

There are no minimum order quantity requirements.

**Payment Terms**

Net 30 Days on established credit.

**Payment Options**

We accept check, Visa, MasterCard, Discover, AMEX, and ACH.

**Sales Tax**

Sales tax charges apply unless a resale certificate is provided.

**Prices**

All prices listed are in US funds. Our prices are subject to change without prior notice.

**Product Care**

Clean products with a damp, non-abrasive cloth using mild dishwashing liquid and warm water. Wipe dry with a soft cloth; avoid harsh cleaners or waxes to preserve the finish and warranty. Prevent water or soap residue to maintain the protective coating.

**Shipping Claims**

All shipping claims must be submitted in writing within 30 days after the scheduled delivery for packages that have been lost or damaged. Please include the EMTEK order # and/or your PO#, package's tracking number along with photos for any damaged packages.

**Returns**

- For your convenience, returns within the United States do not require authorization. Returns can be processed directly from the Emtek Customer Portal (<https://extranet.assaabloydss.com/extranet/loginindss.htm>) or Emtek Dealer Site (<https://www.emtek.com/dealer-sign-in/>).
- All returns from outside of the United States will require pre-authorization. Please contact Emtek Customer Service at 800-356-2741, option 4 or email your request to [rga@emtek.com](mailto:rga@emtek.com).
- EMTEK Customer Portal: Once you are logged into your account, locate the original order under the Shipped section and select Request CCF/RGA. A link to generate a UPS call tag can be found under the Tools drop down menu. Terms and conditions apply – see the website for details.
- EMTEK Dealer Site: After logging in, select Returns. Fill out the RGA Form and follow the link to generate a UPS call tag. Terms and conditions apply – see the website for details.
- Returns will only be accepted for products shipped within 180 days of invoice date.
- A completed RGA form must accompany all packages for returned goods.
- Returns are accepted from the EMTEK dealer who originally purchased the product that is being returned. Any refund or credit would only be made to the original dealer.
- All returned goods are subject to a minimum 25% restocking fee.
- Returns for reasons other than an EMTEK factory or processing error will be subject to our customary restocking fee with a return freight charge of \$20.00 per label/carton in the United States or \$35.00 per label/carton in Canada or Mexico. This charge will be deducted from the credit issued for each call tag.

**SHIPPING AND FREIGHT****Shipping Costs**

All orders are FOB shipping point. For shipments to a dealer-specified commercial address located in the US, Canada and Mexico, EMTEK ships freight prepaid. For shipments to dealers located outside of North America, freight will be prepaid by EMTEK and to the U.S. location of the dealer's freight forwarder. Orders may ship ground service or LTL at our discretion. Orders shipping to a residential address will automatically ship via ground service with a 10% surcharge.

**Shipping Options**

Shipments may be expedited for a fee. Unfortunately, a dealer's freight account cannot be used to pay for shipping charges.

Delivery Location	Type of Service	Surcharge %*
Commercial Address	Next Day	16%
Commercial Address	Second Day	6%
Residential Address	Next Day	25%
Residential Address	Second Day	20%
Residential Address	Three Day	15%
Residential Address	Ground (Default Service)	10%

\*Multiplied by invoice value

**Order Lead Time**

EMTEK assembles all products to order in our Southern California facility. Orders typically ship within two to three business days once an order is released to the factory.

**DEALER INFORMATION PORTAL****Online Account Access and Web Shop**

We are pleased to offer you access to your EMTEK account information, place new orders, and initiate Product Returns (RGA) through the EMTEK Customer Portal. Through the customer portal, you can access information about your account at any time. You can:

- Check on the status of orders
- View both order and sales history
- View and print order acknowledgments, invoices, statements, and credits
- Track shipments
- Initiate Product Return/RGA
- Place a new order via the EMTEK Web Shop

To register for the EMTEK Customer Portal or to make changes to access rights, we require the approval from your company's owner, CEO, President or other corporate officer. To get started, click on the "Dealer Sign In" icon on [www.emtek.com](http://www.emtek.com), and then select "Forms". Please complete the "EMTEK Customer Portal Access Rights Form" and email to: [customerportal@emtek.com](mailto:customerportal@emtek.com). Should you have any questions, please contact Customer Service.

## NO CHARGE SAMPLE PROGRAM

---

### Sample Program

Samples are gladly provided at no charge to authorized dealers under the following conditions:

- Passage, privacy or dummy function (max 3)

A shipping and handling fee of \$4.00 per sample will be applied to your order (\$4.00 for one sample, \$6.00 for two samples, \$9.00 for three samples)

### Sample Order Requirements

- Samples must be different product codes.
- Samples do not include keyed product and entry sets.

### Placing a Sample Order

- Send orders to [samples@emtek.com](mailto:samples@emtek.com) or place by fax, phone or mail.
- Write "NO CHARGE SAMPLE" on the order.
- Standard shipment upgrade charges will apply for expedited freight requests.
- Orders for sample products must be placed separately and not combined with other products.
- EMTEK does not require samples to be returned.

## NO CHARGE DISPLAY PROGRAM

---

### Display Program

Yale Expressions™ Series offers a variety of quality, well-crafted displays

- For the current display offerings, see page 46 of this price book.
- For the most up-to-date display offerings, please click on the "Dealer Sign In" on the [www.emtek.com](http://www.emtek.com) home page, and then select "Yale Expressions™ Series".

### Placing a Display Order

Please contact your local sales representative for ordering information.

### Product for use on Displays in your Showroom

Thank you for considering Yale Expressions™ Series products for use on door displays installed in your showroom. Please contact your local sales representative for ordering information.

## Minimum Advertised Price Policy – Yale Expressions™ Series

---

Effective September 1, 2020

EMTEK has determined that in order to better compete against existing competitors it must exercise a greater degree of control over the distribution of its products. Therefore, all sales of Yale Expressions™ products will be subject to this Policy. This Policy has been unilaterally adopted and will be enforced strictly and uniformly.

Although resellers remain free to establish their own resale prices, to the extent that any customer elects to advertise products of Yale Expressions™ in any manner, that is in print, in electronic media, on its website, etc., and provides price information for such products, that price information must be no less than List Price less 30%, this is the Minimum Advertised Price (MAP). Advertisements and offers to sell that do not include a particular price, but require further action that implies a price that is lower than the Minimum Advertised Price violate the MAP Policy. Examples of such unauthorized advertisements include "drop in cart" pricing, "add to cart" pricing, "click to see" pricing, and discount coupon pricing. Also prohibited are advertisements that indicate that discounts may be available when a customer takes specific action that goes beyond buying the product, such as "special price option" or "name your price."

To assure fair business practices, we will strictly enforce this policy. Violations of this MAP Policy will include termination of our business relationship with a customer. On the first offense there will be a written notice counseling any customer that disregards this policy. Any customer who violates the policy a second time, within one year of receiving a written notice of a first violation, will be terminated.

EMTEK will not discuss any conditions of acceptance related to this Policy, as it is non-negotiable and will not be altered for any dealer. In addition, EMTEK neither solicits, nor will it accept, any assurance of compliance with this Policy. Nothing in this Policy shall constitute an agreement between EMTEK and any reseller that the reseller will comply with this Policy.

MARCEL









## Marcel - Modern

A simply modern door hardware series, Marcel highlights clean shapes, perpendicular lines, and contemporary forms. Versatile enough for a mid-century modern ranch home or a century-old craftsman bungalow, Marcel delivers a fresh look with smooth, reliable action.



MARCEL

	PRODUCT	FUNCTION	PRODUCT CODE	FINISH	LIST PRICE
	Marcel Entry Set with Nils Lever	ENTRANCE	<b>YMRC44.NIL</b>	Satin Brass (US4) Satin Nickel (US15) Flat Black (US19) Polished Chrome (US26)	<b>\$198.00</b>
	Marcel Entry Set with Holden Lever	ENTRANCE	<b>YMRC44.HLD</b>		<b>\$198.00</b>
	Marcel Entry Set with Dylan Knob	ENTRANCE	<b>YMRC44.DYL</b>		<b>\$171.00</b>
	Marcel Deadbolt	DEADBOLT	<b>YMRC32</b>		<b>\$50.00</b>
	Marcel Rosette with Nils Lever	KEYED	<b>YMRC52.NIL</b>		<b>\$57.00</b>
		PASSAGE	<b>YMRC23.NIL</b>		<b>\$43.00</b>
		PRIVACY	<b>YMRC24.NIL</b>		<b>\$43.00</b>
		DUMMY (Pair)	<b>YMRC25.NIL</b>		<b>\$43.00</b>
	Marcel Rosette with Holden Lever	KEYED	<b>YMRC52.HLD</b>		<b>\$57.00</b>
		PASSAGE	<b>YMRC23.HLD</b>		<b>\$43.00</b>
		PRIVACY	<b>YMRC24.HLD</b>		<b>\$43.00</b>
		DUMMY (Pair)	<b>YMRC25.HLD</b>		<b>\$43.00</b>
	Marcel Rosette with Dylan Knob	KEYED	<b>YMRC52.DYL</b>		<b>\$49.00</b>
		PASSAGE	<b>YMRC23.DYL</b>		<b>\$41.00</b>
		PRIVACY	<b>YMRC24.DYL</b>		<b>\$41.00</b>
		DUMMY (Pair)	<b>YMRC25.DYL</b>		<b>\$41.00</b>

- **Universal handing. Fits both right and left-handed doors**
- Fits standard door thickness of 1 $\frac{3}{8}$ " - 1 $\frac{3}{4}$ "
- Includes a 2 $\frac{3}{8}$ " or 2 $\frac{1}{4}$ " adjustable latch
- See pages 43-44 for handing and technical specifications

**Keyways**

- Includes Schlage (SC1) keyway as standard
- Optional **Kwikset (KW1)** keyway. Specify by adding "K" to the beginning of the product code
- Optional **Weiser (WR5)** keyway. Specify by adding "W" to the beginning of the product code





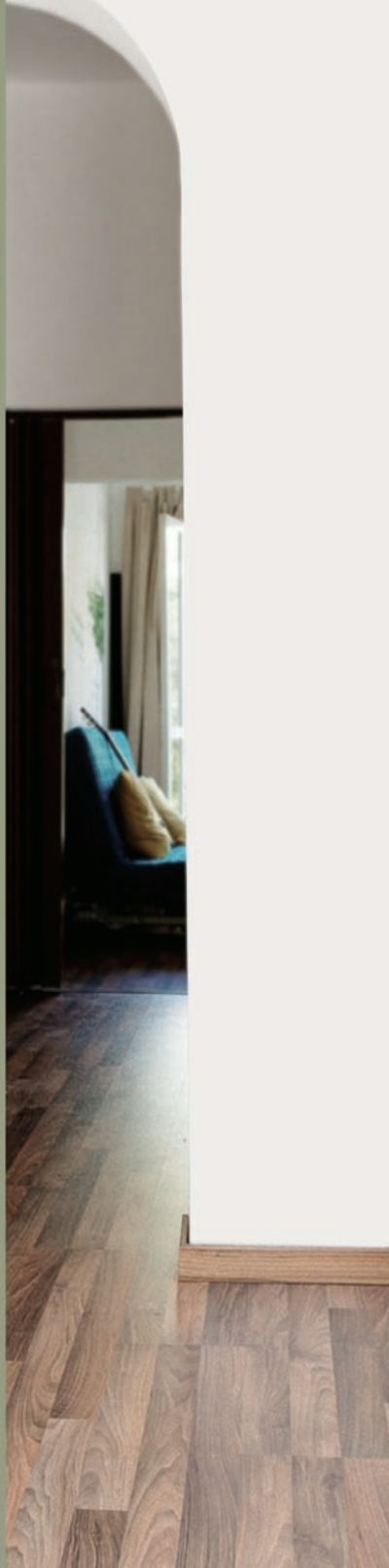

To order: (Optional: **K** or **W**) + Product Code + Finish

ELLINGTON



## Ellington - Transitional

With delicate beveling and a transitional profile, the Ellington series balances new and old for a polished look. Perfect for a traditional Cape Cod home or an updated Tudor, the Ellington showcases the best of both stylistic worlds with ease.

	PRODUCT	FUNCTION	PRODUCT CODE	FINISH	LIST PRICE
	Ellington Entry Set with Brunswick Lever (Left Handed)	ENTRANCE	<b>YELT44.BWKLH</b>	Oil Rubbed Bronze (US10B) Satin Nickel (US15) Flat Black (US19) Polished Chrome (US26)	<b>\$198.00</b>
	Ellington Entry Set with Brunswick Lever (Right Handed)	ENTRANCE	<b>YELT44.BWKRH</b>		<b>\$198.00</b>
	Ellington Entry Set with Walker Knob	ENTRANCE	<b>YELT44.WLK</b>		<b>\$171.00</b>
					
	Ellington Deadbolt	DEADBOLT	<b>YELT32</b>		<b>\$62.00</b>
	Ellington Rosette with Brunswick Lever	KEYED PASSAGE PRIVACY DUMMY (Pair)	<b>YELT52.BWK</b> <b>YELT23.BWK</b> <b>YELT24.BWK</b> <b>YELT25.BWK</b>		<b>\$71.00</b> <b>\$54.00</b> <b>\$54.00</b> <b>\$54.00</b>
	Ellington Rosette with Walker Knob	KEYED PASSAGE PRIVACY DUMMY (Pair)	<b>YELT52.WLK</b> <b>YELT23.WLK</b> <b>YELT24.WLK</b> <b>YELT25.WLK</b>		<b>\$61.00</b> <b>\$52.00</b> <b>\$52.00</b> <b>\$52.00</b>

**ELLINGTON**

- **Universal handing unless otherwise specified**
- Fits standard door thickness of 1 $\frac{3}{8}$ " - 1 $\frac{1}{2}$ "
- Includes a 2 $\frac{3}{8}$ " or 2 $\frac{1}{4}$ " adjustable latch
- See pages 43-44 for handing and technical specifications

**Keyways**

- Includes Schlage (SC1) keyway as standard
- Optional **Kwikset (KW1)** keyway. Specify by adding "K" to the beginning of the product code
- Optional **Weiser (WR5)** keyway. Specify by adding "W" to the beginning of the product code









To order: (Optional: **K** or **W**) + Product Code + Finish

EVERLY



## Everly - Traditional

A collection that honors American Colonial Revival Architecture, the Everly is characterized by its arched rosettes and classically elegant combinations. This series would be as at home in a southern-style farmhouse as it would be in a refined New England retreat.

	PRODUCT	FUNCTION	PRODUCT CODE	FINISH	LIST PRICE
	Everly Entry Set with Farmington Lever (Left Handed)	ENTRANCE	<b>YEVY44.FMTLH</b>	Polished Brass (US3) Oil Rubbed Bronze (US10B) Satin Nickel (US15) Polished Chrome (US26)	<b>\$198.00</b>
	Everly Entry Set with Farmington Lever (Right Handed)	ENTRANCE	<b>YEVY44.FMTRH</b>		<b>\$198.00</b>
	Everly Entry Set with Auburn Knob	ENTRANCE	<b>YEVY44.ABN</b>		<b>\$171.00</b>
					
	Everly Entry Set with Lewiston Knob	ENTRANCE	<b>YEVY44.LTN</b>		<b>\$171.00</b>
	Everly Deadbolt	DEADBOLT	<b>YEVY32</b>		<b>\$62.00</b>
	Everly Rosette with Farmington Lever	KEYED	<b>YEVY52.FMT</b>		<b>\$71.00</b>
		PASSAGE	<b>YEVY23.FMT</b>		<b>\$54.00</b>
		PRIVACY	<b>YEVY24.FMT</b>		<b>\$54.00</b>
		DUMMY (Pair)	<b>YEVY25.FMT</b>		<b>\$54.00</b>
	Everly Rosette with Auburn Knob	KEYED	<b>YEVY52.ABN</b>		<b>\$61.00</b>
		PASSAGE	<b>YEVY23.ABN</b>		<b>\$52.00</b>
		PRIVACY	<b>YEVY24.ABN</b>		<b>\$52.00</b>
		DUMMY (Pair)	<b>YEVY25.ABN</b>		<b>\$52.00</b>
	Everly Rosette with Lewiston Knob	KEYED	<b>YEVY52.LTN</b>		<b>\$61.00</b>
		PASSAGE	<b>YEVY23.LTN</b>		<b>\$52.00</b>
		PRIVACY	<b>YEVY24.LTN</b>		<b>\$52.00</b>
		DUMMY (Pair)	<b>YEVY25.LTN</b>		<b>\$52.00</b>

- **Universal handing unless otherwise specified**
- Fits standard door thickness of 1 $\frac{3}{8}$ " - 1 $\frac{3}{4}$ "
- Includes a 2 $\frac{3}{8}$ " or 2 $\frac{1}{2}$ " adjustable latch
- See pages 43-44 for handing and technical specifications

**Keyways**

- Includes Schlage (SC1) keyway as standard
- Optional **Kwikset (KW1)** keyway. Specify by adding "K" to the beginning of the product code
- Optional **Weiser (WR5)** keyway. Specify by adding "W" to the beginning of the product code

To order: (Optional: **K** or **W**) + Product Code + Finish

MAGUIRE



## Maguire - Traditional

Classic Americana, the Maguire series delivers a traditional door hardware style as nostalgic as baseball and apple pie. We imagine it on a Ranch style home or perhaps a classic cottage hideaway, but Maguire's good looks are all purpose enough for you to decide.

	PRODUCT	FUNCTION	PRODUCT CODE	FINISH	LIST PRICE
	Maguire Entry Set with Farmington Lever (Left Handed)	ENTRANCE	<b>YMGR44.FMTLH</b>	Polished Brass (US3) Oil Rubbed Bronze (US10B) Satin Nickel (US15) Polished Chrome (US26)	<b>\$198.00</b>
	Maguire Entry Set with Farmington Lever (Right Handed)	ENTRANCE	<b>YMGR44.FMTRH</b>		<b>\$198.00</b>
	Maguire Entry Set with Auburn Knob	ENTRANCE	<b>YMGR44.ABN</b>		<b>\$171.00</b>
	Maguire Entry Set with Lewiston Knob	ENTRANCE	<b>YMGR44.LTN</b>		<b>\$171.00</b>
	Maguire Deadbolt	DEADBOLT	<b>YMGR32</b>		<b>\$28.00</b>
	Maguire Rosette with Farmington Lever	KEYED	<b>YMGR52.FMT</b>		<b>\$51.00</b>
		PASSAGE	<b>YMGR23.FMT</b>		<b>\$37.00</b>
		PRIVACY	<b>YMGR24.FMT</b>		<b>\$37.00</b>
		DUMMY (Pair)	<b>YMGR25.FMT</b>		<b>\$37.00</b>
	Maguire Rosette with Auburn Knob	KEYED	<b>YMGR52.ABN</b>		<b>\$31.00</b>
		PASSAGE	<b>YMGR23.ABN</b>		<b>\$26.00</b>
		PRIVACY	<b>YMGR24.ABN</b>		<b>\$26.00</b>
		DUMMY (Pair)	<b>YMGR25.ABN</b>		<b>\$26.00</b>
	Maguire Rosette with Lewiston Knob	KEYED	<b>YMGR52.LTN</b>		<b>\$31.00</b>
		PASSAGE	<b>YMGR23.LTN</b>		<b>\$26.00</b>
		PRIVACY	<b>YMGR24.LTN</b>		<b>\$26.00</b>
		DUMMY (Pair)	<b>YMGR25.LTN</b>		<b>\$26.00</b>

- **Universal handing unless otherwise specified**
- Fits standard door thickness of 1 $\frac{3}{8}$ " - 1 $\frac{3}{4}$ "
- Includes a 2 $\frac{3}{8}$ " or 2 $\frac{1}{4}$ " adjustable latch
- See pages 43-44 for handing and technical specifications

**Keyways**

- Includes Schlage (SC1) keyway as standard
- Optional **Kwikset (KW1)** keyway. Specify by adding "K" to the beginning of the product code
- Optional **Weiser (WR5)** keyway. Specify by adding "W" to the beginning of the product code

To order: (Optional: **K** or **W**) + Product Code + Finish



## YALE EXPRESSIONS™ ENTRY SETS

A platform designed to offer purchase flexibility for your new entry set: Either as a complete boxed lockset; or as a separate exterior trim, that can be mix and matched with an interior trim of your choice. Each pairing can be assembled with any combination of knob and lever options available.

Easy to order, quick to ship and stylish to boot, Yale Expressions™ allows homeowners to make an impactful first impression with their front door.

### 3 WAYS TO BUY AN ENTRY SET:

1. Complete Set



2. Exterior Trim



3. Interior Trim Pack

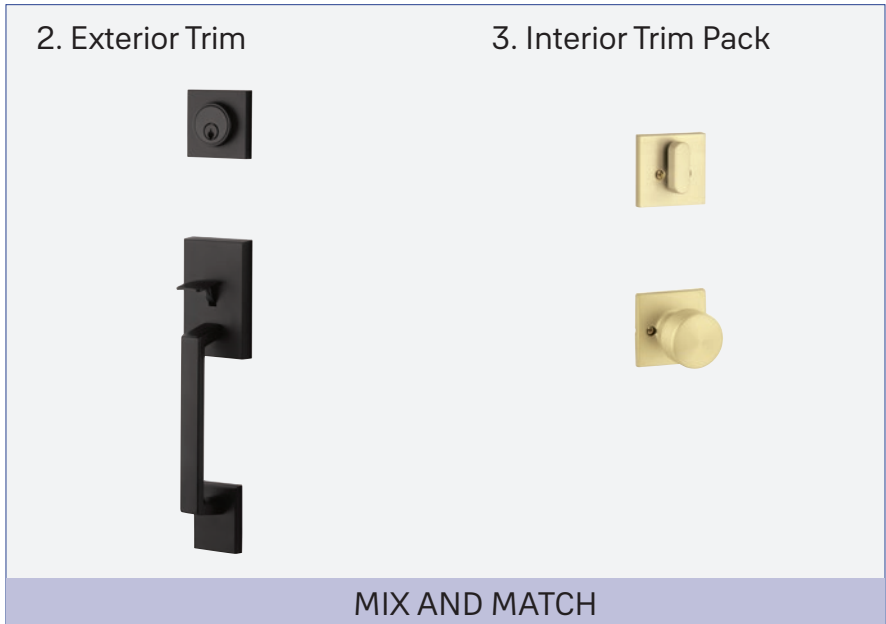





MIX AND MATCH



# COMPLETE SET

## LEVERS





	PACK	PRODUCT	FUNCTION	PRODUCT CODE	FINISH	LIST PRICE
	Exterior + Interior	Marcel Entry Set with Nils Lever	SINGLE CYLINDER	<b>YMRC44.NIL</b>	Satin Brass (US4) Satin Nickel (US15) Flat Black (US19) Polished Chrome (US26)	<b>\$198.00</b>
	Exterior + Interior	Marcel Entry Set with Holden Lever	SINGLE CYLINDER	<b>YMRC44.HLD</b>	Satin Brass (US4) Satin Nickel (US15) Flat Black (US19) Polished Chrome (US26)	<b>\$198.00</b>
	Exterior + Interior	Ellington Entry Set with Brunswick Lever (Left Handed)	SINGLE CYLINDER	<b>YELT44.BWKLH</b>	Oil Rubbed Bronze (US10B) Satin Nickel (US15) Flat Black (US19) Polished Chrome (US26)	<b>\$198.00</b>
	Exterior + Interior	Ellington Entry Set with Brunswick Lever (Right Handed)	SINGLE CYLINDER	<b>YELT44.BWKRH</b>	Oil Rubbed Bronze (US10B) Satin Nickel (US15) Flat Black (US19) Polished Chrome (US26)	<b>\$198.00</b>

- **Universal handing unless otherwise specified**
- Fits standard door thickness of 1 $\frac{3}{8}$ " - 1 $\frac{3}{4}$ "
- Includes a 2 $\frac{3}{8}$ " or 2 $\frac{1}{2}$ " adjustable latch
- See pages 43-44 for handing and technical specifications

### Keyways

- Includes Schlage (SC1) keyway as standard
- Optional **Kwikset (KW1)** keyway. Specify by adding "K" to the beginning of the product code
- Optional **Weiser (WR5)** keyway. Specify by adding "W" to the beginning of the product code

To order: (Optional: **K** or **W**) + Product Code + Finish

PACK	PRODUCT	FUNCTION	PRODUCT CODE	FINISH	LIST PRICE
	Exterior + Interior Everly Entry Set with Farmington Lever (Left Handed)	SINGLE CYLINDER	<b>YEVY44.FMTLH</b>	Polished Brass (US3) Oil Rubbed Bronze (US10B) Satin Nickel (US15) Polished Chrome (US26)	<b>\$198.00</b>
	Exterior + Interior Everly Entry Set with Farmington Lever (Right Handed)	SINGLE CYLINDER	<b>YEVY44.FMTRH</b>	Polished Brass (US3) Oil Rubbed Bronze (US10B) Satin Nickel (US15) Polished Chrome (US26)	<b>\$198.00</b>
	Exterior + Interior Maguire Entry Set with Farmington Lever (Left Handed)	SINGLE CYLINDER	<b>YMGR44.FMTLH</b>	Polished Brass (US3) Oil Rubbed Bronze (US10B) Satin Nickel (US15) Polished Chrome (US26)	<b>\$198.00</b>
	Exterior + Interior Maguire Entry Set with Farmington Lever (Right Handed)	SINGLE CYLINDER	<b>YMGR44.FMTRH</b>	Polished Brass (US3) Oil Rubbed Bronze (US10B) Satin Nickel (US15) Polished Chrome (US26)	<b>\$198.00</b>











**KNOBS**

	Exterior + Interior Marcel Entry Set with Dylan Knob	SINGLE CYLINDER	<b>YMRC44.DYL</b>	Satin Brass (US4) Satin Nickel (US15) Flat Black (US19) Polished Chrome (US26)	<b>\$171.00</b>
---	---	-----------------	-------------------	---	-----------------

- **Universal handing unless otherwise specified**
- Fits standard door thickness of 1<sup>3</sup>/<sub>8</sub>" - 1<sup>3</sup>/<sub>4</sub>"
- Includes a 2<sup>3</sup>/<sub>8</sub>" or 2<sup>1</sup>/<sub>2</sub>" adjustable latch
- See pages 43-44 for handing and technical specifications

- Keyways**
- Includes Schlage (SC1) keyway as standard
  - Optional **Kwikset (KW1)** keyway. Specify by adding "K" to the beginning of the product code
  - Optional **Weiser (WR5)** keyway. Specify by adding "W" to the beginning of the product code

To order: (Optional: **K** or **W**) + Product Code + Finish

PACK	PRODUCT	FUNCTION	PRODUCT CODE	FINISH	LIST PRICE
 	Exterior + Interior Ellington Entry Set with Walker Knob	SINGLE CYLINDER	<b>YELT44.WLK</b>	Oil Rubbed Bronze (US10B) Satin Nickel (US15) Flat Black (US19) Polished Chrome (US26)	<b>\$171.00</b>
 	Exterior + Interior Every Entry Set with Auburn Knob	SINGLE CYLINDER	<b>YEVY44.ABN</b>	Polished Brass (US3) Oil Rubbed Bronze (US10B) Satin Nickel (US15) Polished Chrome (US26)	<b>\$171.00</b>
 	Exterior + Interior Every Entry Set with Lewiston Knob	SINGLE CYLINDER	<b>YEVY44.LTN</b>	Polished Brass (US3) Oil Rubbed Bronze (US10B) Satin Nickel (US15) Polished Chrome (US26)	<b>\$171.00</b>
 	Exterior + Interior Maguire Entry Set with Auburn Knob	SINGLE CYLINDER	<b>YMGR44.ABN</b>	Polished Brass (US3) Oil Rubbed Bronze (US10B) Satin Nickel (US15) Polished Chrome (US26)	<b>\$171.00</b>
 	Exterior + Interior Maguire Entry Set with Lewiston Knob	SINGLE CYLINDER	<b>YMGR44.LTN</b>	Polished Brass (US3) Oil Rubbed Bronze (US10B) Satin Nickel (US15) Polished Chrome (US26)	<b>\$171.00</b>









- **Universal handing. Fits both right and left-handed doors**
- Fits standard door thickness of 1 $\frac{3}{8}$ " - 1 $\frac{1}{2}$ "
- Includes a 2 $\frac{3}{8}$ " or 2 $\frac{1}{2}$ " adjustable latch
- See pages 43-44 for handing and technical specifications

**Keyways**

- Includes Schlage (SC1) keyway as standard
- Optional **Kwikset (KW1)** keyway. Specify by adding "K" to the beginning of the product code
- Optional **Weiser (WR5)** keyway. Specify by adding "W" to the beginning of the product code

To order: (Optional: **K** or **W**) + Product Code + Finish

# EXTERIOR TRIM

	PACK	PRODUCT	FUNCTION	PRODUCT CODE	FINISH	LIST PRICE
 	Exterior Trim	Marcel Trim	SINGLE CYLINDER	<b>YMRC42</b>	Satin Brass (US4) Satin Nickel (US15) Flat Black (US19) Polished Chrome (US26)	<b>\$136.00</b>
 	Exterior Trim	Ellington Trim	SINGLE CYLINDER	<b>YELT42</b>	Oil Rubbed Bronze (US10B) Satin Nickel (US15) Flat Black (US19) Polished Chrome (US26)	<b>\$136.00</b>
 	Exterior Trim	Every Trim	SINGLE CYLINDER	<b>YEVY42</b>	Polished Brass (US3) Oil Rubbed Bronze (US10B) Satin Nickel (US15) Polished Chrome (US26)	<b>\$136.00</b>
 	Exterior Trim	Maguire Trim	SINGLE CYLINDER	<b>YMGR42</b>	Polished Brass (US3) Oil Rubbed Bronze (US10B) Satin Nickel (US15) Polished Chrome (US26)	<b>\$136.00</b>

- **Universal handing. Fits both right and left-handed doors**
- Fits standard door thickness of 1 3/8" - 1 3/4"
- Includes a 2 3/8" or 2 3/4" adjustable latch
- See page 43 for handing and technical specifications







**Keyways**

- Includes Schlage (SC1) keyway as standard
- Optional **Kwikset (KW1)** keyway. Specify by adding "K" to the beginning of the product code
- Optional **Weiser (WR5)** keyway. Specify by adding "W" to the beginning of the product code

To order: (Optional: **K** or **W**) + Product Code + Finish

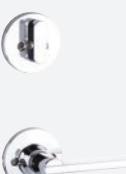











# INTERIOR TRIM PACK

## LEVERS

	PACK	PRODUCT	FUNCTION	PRODUCT CODE	FINISH	LIST PRICE
	Interior Trim Pack	Marcel Trim with Nils Lever	SINGLE CYLINDER	<b>YMRC43.NIL</b>	Satin Brass (US4) Satin Nickel (US15) Flat Black (US19) Polished Chrome (US26)	<b>\$62.00</b>
	Interior Trim Pack	Marcel Trim with Holden Lever	SINGLE CYLINDER	<b>YMRC43.HLD</b>	Satin Brass (US4) Satin Nickel (US15) Flat Black (US19) Polished Chrome (US26)	<b>\$62.00</b>
	Interior Trim Pack	Owen Trim with Nils Lever	SINGLE CYLINDER	<b>YOWN43.NIL</b>	Satin Brass (US4) Satin Nickel (US15) Flat Black (US19) Polished Chrome (US26)	<b>\$62.00</b>
	Interior Trim Pack	Owen Trim with Holden Lever	SINGLE CYLINDER	<b>YOWN43.HLD</b>	Satin Brass (US4) Satin Nickel (US15) Flat Black (US19) Polished Chrome (US26)	<b>\$62.00</b>
	Interior Trim Pack	Owen Trim with Brunswick Lever (Left Handed)	SINGLE CYLINDER	<b>YOWN43.BWKLH</b>	Oil Rubbed Bronze (US10B) Satin Nickel (US15) Flat Black (US19) Polished Chrome (US26)	<b>\$62.00</b>
	Interior Trim Pack	Owen Trim with Brunswick Lever (Right Handed)	SINGLE CYLINDER	<b>YOWN43.BWKRH</b>	Oil Rubbed Bronze (US10B) Satin Nickel (US15) Flat Black (US19) Polished Chrome (US26)	<b>\$62.00</b>



- **Universal handing unless otherwise specified**
- Fits standard door thickness of 1 $\frac{3}{8}$ " - 1 $\frac{3}{4}$ "
- Includes a 2 $\frac{3}{8}$ " or 2 $\frac{3}{4}$ " adjustable latch
- See pages 43-44 for handing and technical specifications

To order: Product Code + Finish









	PACK	PRODUCT	FUNCTION	PRODUCT CODE	FINISH	LIST PRICE
	Interior Trim Pack	Ellington Trim with Brunswick Lever (Left Handed)	SINGLE CYLINDER	<b>YELT43.BWKLH</b>	Oil Rubbed Bronze (US10B) Satin Nickel (US15) Flat Black (US19) Polished Chrome (US26)	<b>\$62.00</b>
						
	Interior Trim Pack	Ellington Trim with Brunswick Lever (Right Handed)	SINGLE CYLINDER	<b>YELT43.BWKRH</b>	Oil Rubbed Bronze (US10B) Satin Nickel (US15) Flat Black (US19) Polished Chrome (US26)	<b>\$62.00</b>
						
	Interior Trim Pack	Maguire Trim with Brunswick Lever (Left Handed)	SINGLE CYLINDER	<b>YMGR43.BWKLH</b>	Oil Rubbed Bronze (US10B) Satin Nickel (US15) Flat Black (US19) Polished Chrome (US26)	<b>\$62.00</b>
						
	Interior Trim Pack	Maguire Trim with Brunswick Lever (Right Handed)	SINGLE CYLINDER	<b>YMGR43.BWKRH</b>	Oil Rubbed Bronze (US10B) Satin Nickel (US15) Flat Black (US19) Polished Chrome (US26)	<b>\$62.00</b>
						
	Interior Trim Pack	Every Trim with Farmington Lever (Left Handed)	SINGLE CYLINDER	<b>YEVY43.FMTLH</b>	Polished Brass (US3) Oil Rubbed Bronze (US10B) Satin Nickel (US15) Polished Chrome (US26)	<b>\$62.00</b>
						
	Interior Trim Pack	Every Trim with Farmington Lever (Right Handed)	SINGLE CYLINDER	<b>YEVY43.FMTRH</b>	Polished Brass (US3) Oil Rubbed Bronze (US10B) Satin Nickel (US15) Polished Chrome (US26)	<b>\$62.00</b>
						

- **Universal handing unless otherwise specified**
- Fits standard door thickness of 1 $\frac{1}{8}$ " - 1 $\frac{3}{4}$ "
- Includes a 2 $\frac{3}{8}$ " or 2 $\frac{3}{4}$ " adjustable latch
- See pages 43-44 for handing and technical specifications

To order: Product Code + Finish



PACK	PRODUCT	FUNCTION	PRODUCT CODE	FINISH	LIST PRICE
	Interior Trim Pack Maguire Trim with Farmington Lever (Left Handed)	SINGLE CYLINDER	<b>YMGR43.FMTLH</b>	Polished Brass (US3) Oil Rubbed Bronze (US10B) Satin Nickel (US15) Polished Chrome (US26)	<b>\$62.00</b>
	Interior Trim Pack Maguire Trim with Farmington Lever (Right Handed)	SINGLE CYLINDER	<b>YMGR43.FMTRH</b>	Polished Brass (US3) Oil Rubbed Bronze (US10B) Satin Nickel (US15) Polished Chrome (US26)	<b>\$62.00</b>

**KNOBS**

	Interior Trim Pack Marcel Trim with Dylan Knob	SINGLE CYLINDER	<b>YMRC43.DYL</b>	Satin Brass (US4) Satin Nickel (US15) Flat Black (US19) Polished Chrome (US26)	<b>\$36.00</b>
					
	Interior Trim Pack Owen Trim with Dylan Knob	SINGLE CYLINDER	<b>YOWN43.DYL</b>	Satin Brass (US4) Satin Nickel (US15) Flat Black (US19) Polished Chrome (US26)	<b>\$36.00</b>
					
	Interior Trim Pack Owen Trim with Walker Knob	SINGLE CYLINDER	<b>YOWN43.WLK</b>	Oil Rubbed Bronze (US10B) Satin Nickel (US15) Flat Black (US19) Polished Chrome (US26)	<b>\$36.00</b>
					
	Interior Trim Pack Ellington Trim with Walker Knob	SINGLE CYLINDER	<b>YELT43.WLK</b>	Oil Rubbed Bronze (US10B) Satin Nickel (US15) Flat Black (US19) Polished Chrome (US26)	<b>\$36.00</b>
					

- **Universal handing unless otherwise specified**
- Fits standard door thickness of 1 $\frac{3}{8}$ " - 1 $\frac{1}{2}$ "
- Includes a 2 $\frac{3}{8}$ " or 2 $\frac{1}{4}$ " adjustable latch
- See pages 43-44 for handing and technical specifications

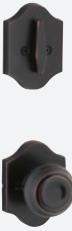
To order: Product Code + Finish

	PACK	PRODUCT	FUNCTION	PRODUCT CODE	FINISH	LIST PRICE
	Interior Trim Pack	Maguire Trim with Walker Knob	SINGLE CYLINDER	<b>YMGR43.WLK</b>	Oil Rubbed Bronze (US10B) Satin Nickel (US15) Flat Black (US19) Polished Chrome (US26)	<b>\$36.00</b>
	Interior Trim Pack	Everly Trim with Auburn Knob	SINGLE CYLINDER	<b>YEVY43.ABN</b>	Polished Brass (US3) Oil Rubbed Bronze (US10B) Satin Nickel (US15) Polished Chrome (US26)	<b>\$36.00</b>
	Interior Trim Pack	Everly Trim with Lewiston Knob	SINGLE CYLINDER	<b>YEVY43.LTN</b>	Polished Brass (US3) Oil Rubbed Bronze (US10B) Satin Nickel (US15) Polished Chrome (US26)	<b>\$36.00</b>
	Interior Trim Pack	Maguire Trim with Auburn Knob	SINGLE CYLINDER	<b>YMGR43.ABN</b>	Polished Brass (US3) Oil Rubbed Bronze (US10B) Satin Nickel (US15) Polished Chrome (US26)	<b>\$36.00</b>
	Interior Trim Pack	Maguire Trim with Lewiston Knob	SINGLE CYLINDER	<b>YMGR43.LTN</b>	Polished Brass (US3) Oil Rubbed Bronze (US10B) Satin Nickel (US15) Polished Chrome (US26)	<b>\$36.00</b>

- **Universal handing. Fits both right and left-handed doors**
- Fits standard door thickness of 1 $\frac{3}{8}$ " - 1 $\frac{3}{4}$ "
- Includes a 2 $\frac{3}{8}$ " or 2 $\frac{1}{2}$ " adjustable latch
- See pages 43-44 for handing and technical specifications

To order: Product Code + Finish



- Solid Brass construction
- Additional style and finish options
- Key alike with other Expressions™ keyed functions (SC1 & WR5 only)
- Coordinate with Expressions™ interior levers and knobs



Baden  
4820

Davos  
4818

Lausanne  
4819



Square Rosette  
with Helios Lever



Square Rosette  
with Stuttgart Lever



Square Rosette  
with Round Knob



Disk Rosette  
with Helios Lever



Disk Rosette  
with Stuttgart Lever



Disk Rosette  
with Round Knob

### EXPRESSIONS™ SERIES



Marcel Rosette  
with Nils Lever



Marcel Rosette  
with Holden Lever



Marcel Rosette  
with Dylan Knob



Owen Rosette  
with Nils Lever

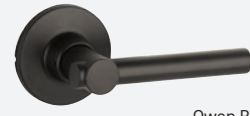

Owen Rosette  
with Holden Lever



Owen Rosette  
with Dylan Knob



Nashville  
4312

Richmond  
4313

Wilmington  
4314



#8 Rosette  
with Elan Lever



#8 Rosette  
with Egg Knob



#8 Rosette  
with Norwich  
Knob



Everly Rosette  
with Farmington  
Lever



Everly Rosette  
with Auburn Knob



Everly Rosette  
with Lewiston Knob

- Solid Brass construction
- Additional style and finish options
- Key alike with other Expressions™ keyed functions (SC1 & WR5 only)
- Coordinate with Expressions™ interior levers and knobs

### EXPRESSIONS™ SERIES



Transitional Heritage  
Sectional  
4716



Transitional Heritage Monolithic  
4717



Quincy Rosette  
with Luzern Lever



Disk Rosette  
with Luzern Lever



Regular Rosette  
with Cortina Lever



Quincy Rosette  
with Laurent Knob



Regular Rosette  
with Providence  
Knob



Ellington Rosette  
with Brunswick Lever



Owen Rosette  
with Brunswick Lever



Maguire Rosette  
with Brunswick Lever



Ellington Rosette  
with Walker Knob



Maguire Rosette  
with Walker Knob



Saratoga  
4410



Marietta  
4411



Regular Rosette  
with Elan Lever



Regular Rosette  
with Egg Knob



Regular Rosette  
with Norwich Knob



Maguire Rosette  
with Farmington  
Lever







Maguire Rosette  
with Auburn Knob



Maguire Rosette  
with Lewiston Knob



	PRODUCT	FUNCTION	PRODUCT CODE	FINISH	LIST PRICE
	Marcel Deadbolt	SINGLE CYLINDER	<b>YMRC32</b>	Satin Brass (US4) Satin Nickel (US15) Flat Black (US19) Polished Chrome (US26)	<b>\$50.00</b>
	Owen Deadbolt	SINGLE CYLINDER	<b>YOWN32</b>	Satin Brass (US4) Satin Nickel (US15) Flat Black (US19) Polished Chrome (US26)	<b>\$50.00</b>
	Ellington Deadbolt	SINGLE CYLINDER	<b>YELT32</b>	Oil Rubbed Bronze (US10B) Satin Nickel (US15) Flat Black (US19) Polished Chrome (US26)	<b>\$62.00</b>
	Everly Deadbolt	SINGLE CYLINDER	<b>YEVY32</b>	Polished Brass (US3) Oil Rubbed Bronze (US10B) Satin Nickel (US15) Polished Chrome (US26)	<b>\$62.00</b>
	Maguire Deadbolt	SINGLE CYLINDER	<b>YMGR32</b>	Polished Brass (US3) Oil Rubbed Bronze (US10B) Satin Nickel (US15) Flat Black (US19) Polished Chrome (US26)	<b>\$28.00</b>

- **Universal handing. Fits both right and left-handed doors**
- Fits standard door thickness of 1 $\frac{3}{8}$ " - 1 $\frac{3}{4}$ "
- Includes a 2 $\frac{3}{8}$ " or 2 $\frac{1}{2}$ " adjustable latch
- See page 43 for technical specifications



- Keyways**
- Includes Schlage (SC1) keyway as standard
  - Optional **Kwikset (KW1)** keyway. Specify by adding "K" to the beginning of the product code
  - Optional **Weiser (WR5)** keyway. Specify by adding "W" to the beginning of the product code

To order: (Optional: **K** or **W**) + Product Code + Finish



KEYED LEVER





	PRODUCT	FUNCTION	PRODUCT CODE	FINISH	LIST PRICE
	Marcel Rosette with Nils Lever	KEYED	<b>YMRC52.NIL</b>	Satin Brass (US4) Satin Nickel (US15) Flat Black (US19) Polished Chrome (US26)	<b>\$57.00</b>
	Marcel Rosette with Holden Lever	KEYED	<b>YMRC52.HLD</b>	Satin Brass (US4) Satin Nickel (US15) Flat Black (US19) Polished Chrome (US26)	<b>\$57.00</b>

- **Universal handing. Fits both right and left-handed doors**
- Fits standard door thickness of 1<sup>3</sup>/<sub>8</sub>" - 1<sup>3</sup>/<sub>4</sub>"
- Includes a 2<sup>3</sup>/<sub>8</sub>" or 2<sup>1</sup>/<sub>4</sub>" adjustable latch
- See page 44 for technical specifications

- Keyways**
- Includes Schlage (SC1) keyway as standard
  - Optional **Kwikset (KW1)** keyway. Specify by adding "K" to the beginning of the product code
  - Optional **Weiser (WR5)** keyway. Specify by adding "W" to the beginning of the product code

To order: (Optional: **K** or **W**) + Product Code + Finish

	PRODUCT	FUNCTION	PRODUCT CODE	FINISH	LIST PRICE
	Owen Rosette with Nils Lever	KEYED	<b>YOWN52.NIL</b>	Satin Brass (US4) Satin Nickel (US15) Flat Black (US19) Polished Chrome (US26)	<b>\$53.00</b>
	Owen Rosette with Holden Lever	KEYED	<b>YOWN52.HLD</b>	Satin Brass (US4) Satin Nickel (US15) Flat Black (US19) Polished Chrome (US26)	<b>\$53.00</b>
	Owen Rosette with Brunswick Lever	KEYED	<b>YOWN52.BWK</b>	Oil Rubbed Bronze (US10B) Satin Nickel (US15) Flat Black (US19) Polished Chrome (US26)	<b>\$51.00</b>
	Ellington Rosette with Brunswick Lever	KEYED	<b>YELT52.BWK</b>	Oil Rubbed Bronze (US10B) Satin Nickel (US15) Flat Black (US19) Polished Chrome (US26)	<b>\$71.00</b>
	Maguire Rosette with Brunswick Lever	KEYED	<b>YMGR52.BWK</b>	Oil Rubbed Bronze (US10B) Satin Nickel (US15) Flat Black (US19) Polished Chrome (US26)	<b>\$51.00</b>
	Everly Rosette with Farmington Lever	KEYED	<b>YEVY52.FMT</b>	Polished Brass (US3) Oil Rubbed Bronze (US10B) Satin Nickel (US15) Polished Chrome (US26)	<b>\$71.00</b>
	Maguire Rosette with Farmington Lever	KEYED	<b>YMGR52.FMT</b>	Polished Brass (US3) Oil Rubbed Bronze (US10B) Satin Nickel (US15) Polished Chrome (US26)	<b>\$51.00</b>

- **Universal handing. Fits both right and left-handed doors**
- Fits standard door thickness of 1 $\frac{3}{8}$ " - 1 $\frac{1}{2}$ "
- Includes a 2 $\frac{3}{8}$ " or 2 $\frac{1}{4}$ " adjustable latch
- See page 44 for technical specifications

#### Keyways



- Includes Schlage (SC1) keyway as standard
- Optional **Kwikset (KW1)** keyway. Specify by adding "K" to the beginning of the product code
- Optional **Weiser (WR5)** keyway. Specify by adding "W" to the beginning of the product code

To order: (Optional: **K** or **W**) + Product Code + Finish



KEYED KNOB









	PRODUCT	FUNCTION	PRODUCT CODE	FINISH	LIST PRICE
	Marcel Rosette with Dylan Knob	KEYED	<b>YMRC52.DYL</b>	Satin Brass (US4) Satin Nickel (US15) Flat Black (US19) Polished Chrome (US26)	<b>\$49.00</b>
	Owen Rosette with Dylan Knob	KEYED	<b>YOWN52.DYL</b>	Satin Brass (US4) Satin Nickel (US15) Flat Black (US19) Polished Chrome (US26)	<b>\$45.00</b>

- **Universal handing. Fits both right and left-handed doors**
- Fits standard door thickness of 1 $\frac{3}{8}$ " - 1 $\frac{3}{4}$ "
- Includes a 2 $\frac{3}{8}$ " or 2 $\frac{1}{4}$ " adjustable latch
- See page 44 for technical specifications

**Keyways**

- Includes Schlage (SC1) keyway as standard
- Optional **Kwikset (KW1)** keyway. Specify by adding "K" to the beginning of the product code
- Optional **Weiser (WR5)** keyway. Specify by adding "W" to the beginning of the product code

To order: (Optional: **K** or **W**) + Product Code + Finish

	PRODUCT	FUNCTION	PRODUCT CODE	FINISH	LIST PRICE
	Owen Rosette with Walker Knob	KEYED	<b>YOWN52.WLK</b>	Oil Rubbed Bronze (US10B) Satin Nickel (US15) Flat Black (US19) Polished Chrome (US26)	<b>\$31.00</b>
	Ellington Rosette with Walker Knob	KEYED	<b>YELT52.WLK</b>	Oil Rubbed Bronze (US10B) Satin Nickel (US15) Flat Black (US19) Polished Chrome (US26)	<b>\$61.00</b>
	Maguire Rosette with Walker Knob	KEYED	<b>YMGR52.WLK</b>	Oil Rubbed Bronze (US10B) Satin Nickel (US15) Flat Black (US19) Polished Chrome (US26)	<b>\$31.00</b>
	Everly Rosette with Auburn Knob	KEYED	<b>YEVY52.ABN</b>	Polished Brass (US3) Oil Rubbed Bronze (US10B) Satin Nickel (US15) Polished Chrome (US26)	<b>\$61.00</b>
	Everly Rosette with Lewiston Knob	KEYED	<b>YEVY52.LTN</b>	Polished Brass (US3) Oil Rubbed Bronze (US10B) Satin Nickel (US15) Polished Chrome (US26)	<b>\$61.00</b>
	Maguire Rosette with Auburn Knob	KEYED	<b>YMGR52.ABN</b>	Polished Brass (US3) Oil Rubbed Bronze (US10B) Satin Nickel (US15) Polished Chrome (US26)	<b>\$31.00</b>
	Maguire Rosette with Lewiston Knob	KEYED	<b>YMGR52.LTN</b>	Polished Brass (US3) Oil Rubbed Bronze (US10B) Satin Nickel (US15) Polished Chrome (US26)	<b>\$31.00</b>

- **Universal handing. Fits both right and left-handed doors**
- Fits standard door thickness of 1 $\frac{3}{8}$ " - 1 $\frac{3}{4}$ "
- Includes a 2 $\frac{3}{8}$ " or 2 $\frac{1}{2}$ " adjustable latch
- See page 44 for technical specifications

#### Keyways

- Includes Schlage (SC1) keyway as standard
- Optional **Kwikset (KW1)** keyway. Specify by adding "K" to the beginning of the product code
- Optional **Weiser (WR5)** keyway. Specify by adding "W" to the beginning of the product code

To order: (Optional: **K** or **W**) + Product Code + Finish

LEVERS



PASSAGE



PRIVACY



PRODUCT

FUNCTION

PRODUCT CODE

FINISH

LIST PRICE

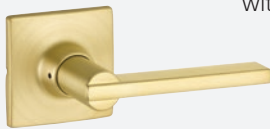

Marcel Rosette  
with Nils Lever

PASSAGE  
PRIVACY  
DUMMY (PAIR)

**YMRC23.NIL**  
**YMRC24.NIL**  
**YMRC25.NIL**

Satin Brass (US4)  
Satin Nickel (US15)  
Flat Black (US19)  
Polished Chrome (US26)

**\$43.00**  
**\$43.00**  
**\$43.00**



Marcel Rosette  
with Holden Lever

PASSAGE  
PRIVACY  
DUMMY (PAIR)

**YMRC23.HLD**  
**YMRC24.HLD**  
**YMRC25.HLD**

Satin Brass (US4)  
Satin Nickel (US15)  
Flat Black (US19)  
Polished Chrome (US26)

**\$43.00**  
**\$43.00**  
**\$43.00**

- **Universal handing. Fits both right and left-handed doors**
- Fits standard door thickness of 1 $\frac{1}{8}$ " - 1 $\frac{3}{4}$ "
- Includes a 2 $\frac{3}{8}$ " or 2 $\frac{1}{4}$ " adjustable latch
- See page 44 for technical specifications

To order: Product Code + Finish





PRODUCT	FUNCTION	PRODUCT CODE	FINISH	LIST PRICE
 <p>Owen Rosette with Nils Lever</p>	PASSAGE	<b>YOWN23.NIL</b>	Satin Brass (US4)	<b>\$40.00</b>
	PRIVACY	<b>YOWN24.NIL</b>	Satin Nickel (US15)	<b>\$40.00</b>
	DUMMY (PAIR)	<b>YOWN25.NIL</b>	Flat Black (US19)	<b>\$40.00</b>
			Polished Chrome (US26)	
 <p>Owen Rosette with Holden Lever</p>	PASSAGE	<b>YOWN23.HLD</b>	Satin Brass (US4)	<b>\$40.00</b>
	PRIVACY	<b>YOWN24.HLD</b>	Satin Nickel (US15)	<b>\$40.00</b>
	DUMMY (PAIR)	<b>YOWN25.HLD</b>	Flat Black (US19)	<b>\$40.00</b>
			Polished Chrome (US26)	
 <p>Owen Rosette with Brunswick Lever</p>	PASSAGE	<b>YOWN23.BWK</b>	Oil Rubbed Bronze (US10B)	<b>\$37.00</b>
	PRIVACY	<b>YOWN24.BWK</b>	Satin Nickel (US15)	<b>\$37.00</b>
	DUMMY (PAIR)	<b>YOWN25.BWK</b>	Flat Black (US19)	<b>\$37.00</b>
			Polished Chrome (US26)	
 <p>Ellington Rosette with Brunswick Lever</p>	PASSAGE	<b>YELT23.BWK</b>	Oil Rubbed Bronze (US10B)	<b>\$54.00</b>
	PRIVACY	<b>YELT24.BWK</b>	Satin Nickel (US15)	<b>\$54.00</b>
	DUMMY (PAIR)	<b>YELT25.BWK</b>	Flat Black (US19)	<b>\$54.00</b>
			Polished Chrome (US26)	
 <p>Maguire Rosette with Brunswick Lever</p>	PASSAGE	<b>YMGR23.BWK</b>	Oil Rubbed Bronze (US10B)	<b>\$37.00</b>
	PRIVACY	<b>YMGR24.BWK</b>	Satin Nickel (US15)	<b>\$37.00</b>
	DUMMY (PAIR)	<b>YMGR25.BWK</b>	Flat Black (US19)	<b>\$37.00</b>
			Polished Chrome (US26)	
 <p>Everly Rosette with Farmington Lever</p>	PASSAGE	<b>YEVY23.FMT</b>	Polished Brass (US3)	<b>\$54.00</b>
	PRIVACY	<b>YEVY24.FMT</b>	Oil Rubbed Bronze (US10B)	<b>\$54.00</b>
	DUMMY (PAIR)	<b>YEVY25.FMT</b>	Satin Nickel (US15)	<b>\$54.00</b>
			Polished Chrome (US26)	
 <p>Maguire Rosette with Farmington Lever</p>	PASSAGE	<b>YMGR23.FMT</b>	Polished Brass (US3)	<b>\$37.00</b>
	PRIVACY	<b>YMGR24.FMT</b>	Oil Rubbed Bronze (US10B)	<b>\$37.00</b>
	DUMMY (PAIR)	<b>YMGR25.FMT</b>	Satin Nickel (US15)	<b>\$37.00</b>
			Polished Chrome (US26)	

- **Universal handing. Fits both right and left-handed doors**
- Fits standard door thickness of 1 $\frac{3}{8}$ " - 1 $\frac{3}{4}$ "
- Includes a 2 $\frac{3}{8}$ " or 2 $\frac{1}{2}$ " adjustable latch
- See page 44 for technical specifications

To order: Product Code + Finish

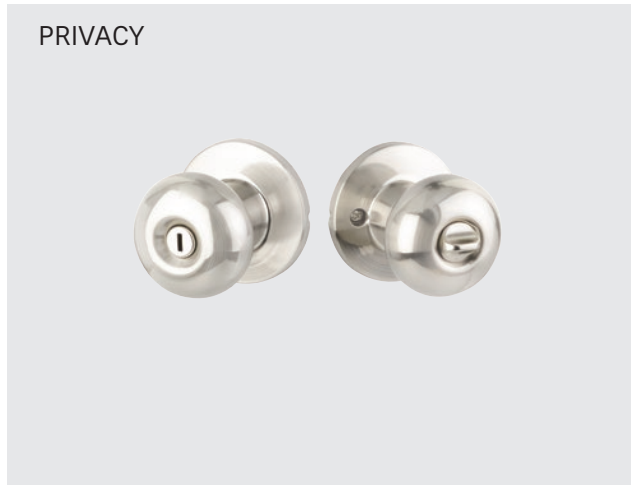
KNOBS



	PRODUCT	FUNCTION	PRODUCT CODE	FINISH	LIST PRICE
	Marcel Rosette with Dylan Knob	PASSAGE	<b>YMRC23.DYL</b>	Satin Brass (US4)	<b>\$41.00</b>
		PRIVACY	<b>YMRC24.DYL</b>	Satin Nickel (US15)	<b>\$41.00</b>
		DUMMY (PAIR)	<b>YMRC25.DYL</b>	Flat Black (US19)	<b>\$41.00</b>
				Polished Chrome (US26)	
	Owen Rosette with Dylan Knob	PASSAGE	<b>YOWN23.DYL</b>	Satin Brass (US4)	<b>\$37.00</b>
		PRIVACY	<b>YOWN24.DYL</b>	Satin Nickel (US15)	<b>\$37.00</b>
		DUMMY (PAIR)	<b>YOWN25.DYL</b>	Flat Black (US19)	<b>\$37.00</b>
				Polished Chrome (US26)	

- Universal handing. Fits both right and left-handed doors
- Fits standard door thickness of 1<sup>3</sup>/<sub>8</sub>" - 1<sup>1</sup>/<sub>2</sub>"
- Includes a 2<sup>3</sup>/<sub>8</sub>" or 2<sup>1</sup>/<sub>4</sub>" adjustable latch
- See page 44 for technical specifications

To order: Product Code + Finish

	PRODUCT	FUNCTION	PRODUCT CODE	FINISH	LIST PRICE
	Owen Rosette with Walker Knob	PASSAGE PRIVACY DUMMY (PAIR)	<b>YOWN23.WLK</b> <b>YOWN24.WLK</b> <b>YOWN25.WLK</b>	Oil Rubbed Bronze (US10B) Satin Nickel (US15) Flat Black (US19) Polished Chrome (US26)	<b>\$26.00</b> <b>\$26.00</b> <b>\$26.00</b>
	Ellington Rosette with Walker Knob	PASSAGE PRIVACY DUMMY (PAIR)	<b>YELT23.WLK</b> <b>YELT24.WLK</b> <b>YELT25.WLK</b>	Oil Rubbed Bronze (US10B) Satin Nickel (US15) Flat Black (US19) Polished Chrome (US26)	<b>\$52.00</b> <b>\$52.00</b> <b>\$52.00</b>
	Maguire Rosette with Walker Knob	PASSAGE PRIVACY DUMMY (PAIR)	<b>YMGR23.WLK</b> <b>YMGR24.WLK</b> <b>YMGR25.WLK</b>	Oil Rubbed Bronze (US10B) Satin Nickel (US15) Flat Black (US19) Polished Chrome (US26)	<b>\$26.00</b> <b>\$26.00</b> <b>\$26.00</b>
	Every Rosette with Auburn Knob	PASSAGE PRIVACY DUMMY (PAIR)	<b>YEVY23.ABN</b> <b>YEVY24.ABN</b> <b>YEVY25.ABN</b>	Polished Brass (US3) Oil Rubbed Bronze (US10B) Satin Nickel (US15) Polished Chrome (US26)	<b>\$52.00</b> <b>\$52.00</b> <b>\$52.00</b>
	Every Rosette with Lewiston Knob	PASSAGE PRIVACY DUMMY (PAIR)	<b>YEVY23.LTN</b> <b>YEVY24.LTN</b> <b>YEVY25.LTN</b>	Polished Brass (US3) Oil Rubbed Bronze (US10B) Satin Nickel (US15) Polished Chrome (US26)	<b>\$52.00</b> <b>\$52.00</b> <b>\$52.00</b>
	Maguire Rosette with Auburn Knob	PASSAGE PRIVACY DUMMY (PAIR)	<b>YMGR23.ABN</b> <b>YMGR24.ABN</b> <b>YMGR25.ABN</b>	Polished Brass (US3) Oil Rubbed Bronze (US10B) Satin Nickel (US15) Polished Chrome (US26)	<b>\$26.00</b> <b>\$26.00</b> <b>\$26.00</b>
	Maguire Rosette with Lewiston Knob	PASSAGE PRIVACY DUMMY (PAIR)	<b>YMGR23.LTN</b> <b>YMGR24.LTN</b> <b>YMGR25.LTN</b>	Polished Brass (US3) Oil Rubbed Bronze (US10B) Satin Nickel (US15) Polished Chrome (US26)	<b>\$26.00</b> <b>\$26.00</b> <b>\$26.00</b>

- **Universal handing. Fits both right and left-handed doors**
- Fits standard door thickness of 1 $\frac{3}{8}$ " - 1 $\frac{1}{2}$ "
- Includes a 2 $\frac{3}{8}$ " or 2 $\frac{1}{4}$ " adjustable latch
- See page 44 for technical specifications

To order: Product Code + Finish



## Barn Door Flat Track Hardware Kit

Yale Expressions™ Barn Door Flat Track Hardware Kit with Soft Open & Close System contains everything you need to easily install a sliding door in your home.

### **NEW Clear Packaging - Perfect for Stocking**

- Packaging allows consumers to view contents and promotes easy product identification
- Cuts through the clutter of crowded retail shelves
- A clear package creates exciting aesthetics and value-added perceptions

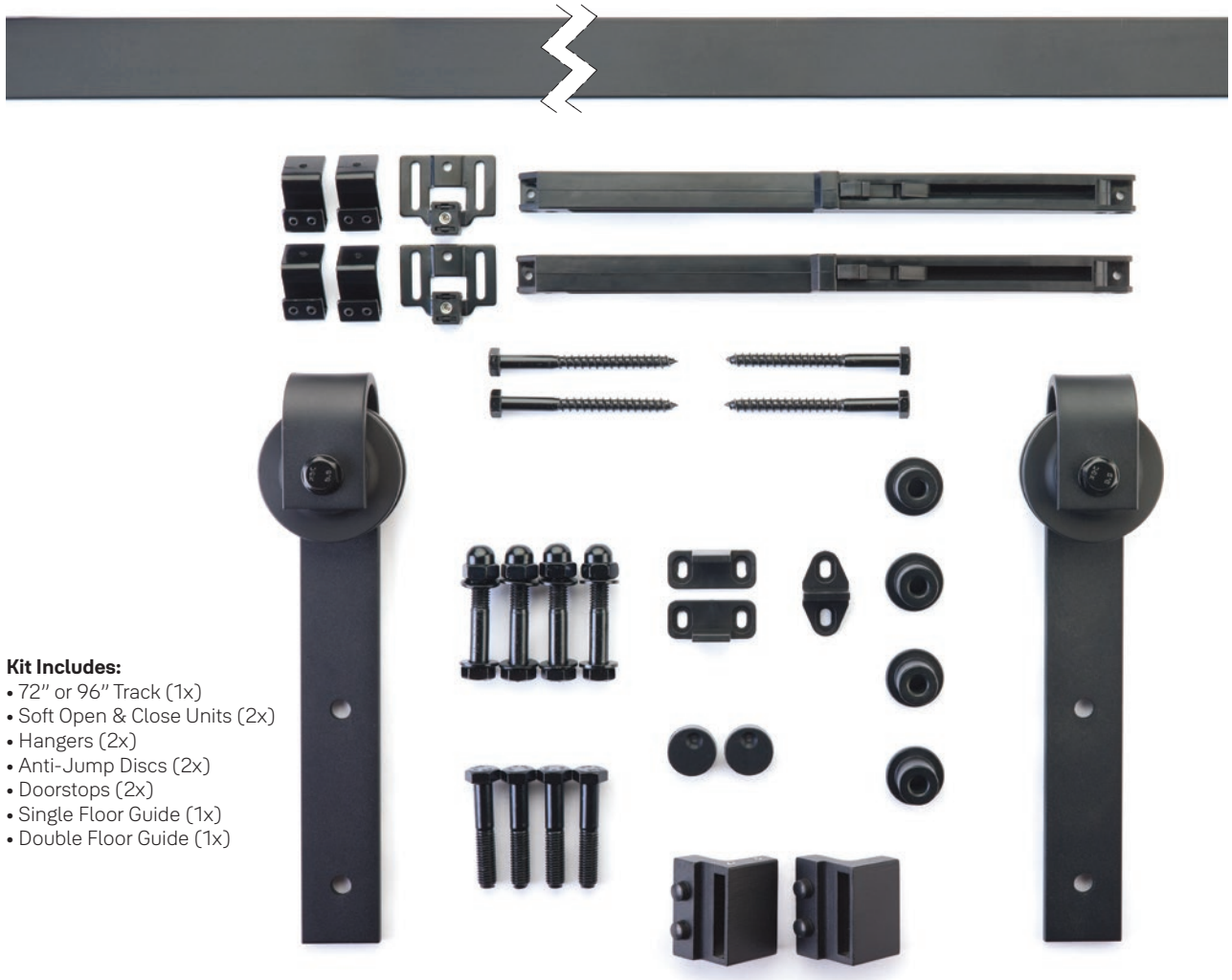

**Kit Includes:**

- 72" or 96" Track (1x)
- Soft Open & Close Units (2x)
- Hangers (2x)
- Anti-Jump Discs (2x)
- Doorstops (2x)
- Single Floor Guide (1x)
- Double Floor Guide (1x)

PRODUCT	FUNCTION	PRODUCT CODE	FINISH	LIST PRICE
72"	Barn Door Track System	<b>YBNDR.72</b>	Black (BLK) Silver (SLVR)	<b>\$270.00</b>
96"	Barn Door Track System	<b>YBNDR.96</b>	Black (BLK) Silver (SLVR)	<b>\$301.00</b>

**Specifications:**

- 1/4" Steel track
- Nylon wheel with ball bearings
- Maximum weight capacity up to 200lb
- Doors 1-3/8" thru 1-3/4" thick
- 72" Track accommodates openings up to 36" wide
- 96" Track accommodates openings up to 48" wide

**Powder Coated Finishes**



**Black**  
BLK



**Silver**  
SLVR

BARN DOOR HANDLES & ACCESSORIES

PRODUCT CODE

FINISH

LIST PRICE



Barn Door Handle with Flush Pull

**YAKBNDR.BFH**

Black (BLK)  
Silver (SLVR)

**\$45.00**



Sliding Door Privacy Lock

**YAKBNDR.PVL**

Black (BLK)  
Silver (SLVR)

**\$17.00**



Adjustable Roller Guide

**YAKBNDR.RG**

Black (BLK)  
Silver (SLVR)

**\$23.00**



Multiple Track Connecting Adaptor

**YAKBNDR.CA**

Black (BLK)  
Silver (SLVR)

**\$15.00**

## TUBULAR POCKET DOOR LOCK

ROUND  
Passage



ROUND  
Privacy



SQUARE  
Passage



SQUARE  
Privacy



	PRODUCT	FUNCTION	PRODUCT CODE	FINISH	LIST PRICE
	Round	PASSAGE TUBULAR PRIVACY TUBULAR	<b>YTPDRND62</b> <b>YTPDRND63</b>	Polished Brass (US3) Satin Brass (US4) Oil Rubbed Bronze (US10B) Satin Nickel (US15) Flat Black (US19) Polished Chrome (US26)	<b>\$27.00</b> <b>\$29.00</b>
	Square	PASSAGE TUBULAR PRIVACY TUBULAR	<b>YTPDSQU62</b> <b>YTPDSQU63</b>	Polished Brass (US3) Satin Brass (US4) Oil Rubbed Bronze (US10B) Satin Nickel (US15) Flat Black (US19) Polished Chrome (US26)	<b>\$31.00</b> <b>\$34.00</b>

- **Universal handing. Fits both right and left-handed doors**
- Fits standard door thickness of 1 $\frac{3}{8}$ " - 1 $\frac{3}{4}$ "
- Includes a 2 $\frac{3}{8}$ " latch
- See page 44 for technical specifications

## POCKET DOOR LOCK

Passage







Privacy





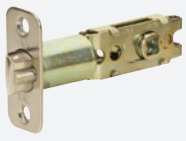

	PRODUCT	FUNCTION	PRODUCT CODE	FINISH	LIST PRICE
	Square	PASSAGE PRIVACY	<b>YPDSQU64</b> <b>YPDSQU65</b>	Polished Brass (US3) Satin Brass (US4) Oil Rubbed Bronze (US10B) Satin Nickel (US15) Flat Black (US19) Polished Chrome (US26)	<b>\$21.00</b> <b>\$23.00</b>

- **Universal handing. Fits both right and left-handed doors**
- Fits standard door thickness of 1 $\frac{3}{8}$ "
- See page 44 for technical specifications





To order: Product Code + Finish







ADJUSTABLE LATCHES		BACKSETS	PRODUCT CODE	FINISH	LIST PRICE
	Keyed Lever, Radius Corner	2-3/8" - 2-3/4"	<b>YAKPPDE.9011</b>	Polished Brass (US3) Satin Brass (US4) Oil Rubbed Bronze (US10B) Satin Nickel (US15) Flat Black (US19) Polished Chrome (US26)	<b>\$7.00</b>
	Keyed Knob, Radius Corner	2-3/8" - 2-3/4"	<b>YAKPPDE.9013</b>		<b>\$7.00</b>
	Deadbolt, Radius Corner	2-3/8" - 2-3/4"	<b>YAKDBT.9009</b>		<b>\$7.00</b>
	Passage/Privacy Lever, Radius Corner	2-3/8" - 2-3/4"	<b>YAKPPDE.9012</b>		<b>\$7.00</b>
	Passage/Privacy Knob, Radius Corner	2-3/8" - 2-3/4"	<b>YAKPPDE.9014</b>		<b>\$7.00</b>

DRIVE-IN ADJUSTABLE LATCHES		BACKSETS	PRODUCT CODE	FINISH	LIST PRICE
	Keyed Lever	2-3/8" - 2-3/4"	<b>YAKPPDE.9031</b>	Polished Chrome (US26)	<b>\$7.00</b>
	Keyed Knob	2-3/8" - 2-3/4"	<b>YAKPPDE.9026</b>		<b>\$7.00</b>
	Deadbolt	2-3/8" - 2-3/4"	<b>YAKPPDE.9027</b>		<b>\$7.00</b>
	Passage/Privacy Lever	2-3/8" - 2-3/4"	<b>YAKPPDE.9030</b>		<b>\$7.00</b>
	Passage/Privacy Knob	2-3/8" - 2-3/4"	<b>YAKPPDE.9025</b>		<b>\$7.00</b>

To order: Product Code + Finish



STRIKE PLATES		DIMENSIONS	PRODUCT CODE	FINISH	LIST PRICE
	Deadbolt Strike Plate, Radius Corner	1" x 2-1/4"	<b>YAKEES.9001</b>	Polished Brass (US3) Satin Brass (US4) Oil Rubbed Bronze (US10B) Satin Nickel (US15) Flat Black (US19) Polished Chrome (US26)	<b>\$3.00</b>
	Full Lip Strike Plate, Radius Corner	1-3/4" x 2-1/4"	<b>YAKEES.9002</b>		<b>\$3.00</b>
	Full Lip Deadbolt Strike Plate, Radius Corner	1-3/4" x 2-1/4"	<b>YAKDBT.9022</b>		<b>\$3.00</b>
	Pocket Door Lock Strike Plate, Radius Corner	1-1/4" x 2-3/4"	<b>YAKPDL.9017</b>		<b>\$3.00</b>

MISC. PARTS		DIMENSIONS	PRODUCT CODE	FINISH	LIST PRICE
	Interior Entry Set Cap and Set Screw	Ø 1" x 5/16"	<b>YAKIES.9024</b>	Polished Brass (US3) Satin Brass (US4) Oil Rubbed Bronze (US10B) Satin Nickel (US15) Flat Black (US19) Polished Chrome (US26)	<b>\$15.00</b>
	Hygiene Multi Tool - Solid Brass	3-3/4" x 1-1/4"	<b>YHFKO-ENTL</b>		<b>\$15.00</b>
	Handing Tool	1-3/4" x 13/16"	<b>YAKTOOL.9033</b>		<b>\$2.00</b>
	Dust Box - Deadbolt Latch	1" x 2" x 1/2"	<b>YAKEES.9004</b>		<b>\$2.00</b>
	Dust Box - Keyed, Passage/Privacy Latch	1" x 2" x 1/2"	<b>YAKEES.9005</b>		<b>\$2.00</b>
	Dust Box - Tubular Pocket Door Lock Latch	1" x 2" x 1/2"	<b>YAKTPDL.9021</b>		<b>\$2.00</b>

KEY BLANK	SPEC	PRODUCT CODE	LIST PRICE
Key Blank - Schlage (SC1)	5-Pin	<b>YSC1-KEYBLNK</b>	<b>\$2.00</b> ea.
Key Blank - Kwikset (KW1)	5-Pin	<b>YKW1-KEYBLNK</b>	<b>\$2.00</b> ea.
Key Blank - Weiser (WR5)	5-Pin	<b>YWR5-KEYBLNK</b>	<b>\$2.00</b> ea.

### KEY CYLINDER AND HOUSING FOR DEADBOLTS (INCLUDES 2 KEYS)

KEY CYLINDER & HOUSING FOR DEADBOLT	SPEC	PRODUCT CODE	FINISH	LIST PRICE
SCHLAGE (SC1) KEYWAY	5-Pin	<b>YSC1CYL-DB</b>	Polished Brass (US3)	<b>\$15.00</b> ea.
KWIKSET (KW1) KEYWAY	5-Pin	<b>YKW1CYL-DB</b>	Satin Brass (US4)	<b>\$15.00</b> ea.
WEISER (WR5) KEYWAY	5-Pin	<b>YWR5CYL-DB</b>	Oil Rubbed Bronze (US10B)	<b>\$15.00</b> ea.
<b>KEY CYLINDER &amp; HOUSING FOR DEADBOLT - MAGUIRE</b>			Satin Nickel (US15)	
			Flat Black (US19)	
			Polished Chrome (US26)	
SCHLAGE (SC1) KEYWAY	5-Pin	<b>YSC1CYL-MGRDB</b>		<b>\$15.00</b> ea.
KWIKSET (KW1) KEYWAY	5-Pin	<b>YKW1CYL-MGRDB</b>		<b>\$15.00</b> ea.
WEISER (WR5) KEYWAY	5-Pin	<b>YWR5CYL-MGRDB</b>		<b>\$15.00</b> ea.

### KEY CYLINDER FOR KEYED LEVERS AND KNOBS (INCLUDES 2 KEYS)

KEY CYLINDER FOR KEYED LEVER	SPEC	PRODUCT CODE	FINISH*	LIST PRICE
SCHLAGE (SC1) KEYWAY	5-Pin	<b>YSC1CYL-LVR</b>	Polished Brass (US3)	<b>\$9.00</b> ea.
KWIKSET (KW1) KEYWAY	5-Pin	<b>YKW1CYL-LVR</b>	Flat Black (US19)	<b>\$9.00</b> ea.
WEISER (WR5) KEYWAY	5-Pin	<b>YWR5CYL-LVR</b>	Polished Chrome (US26)	<b>\$9.00</b> ea.
<b>KEY CYLINDER FOR KEYED KNOB</b>			*For Keyed Lever/Knob: - For US4 use US3 - For US10B use US19 - For US15 use US26	
SCHLAGE (SC1) KEYWAY	5-Pin	<b>YSC1CYL-KNB</b>		<b>\$9.00</b> ea.
KWIKSET (KW1) KEYWAY	5-Pin	<b>YKW1CYL-KNB</b>		<b>\$9.00</b> ea.
WEISER (WR5) KEYWAY	5-Pin	<b>YWR5CYL-KNB</b>		<b>\$9.00</b> ea.
<b>KEY CYLINDER FOR KEYED KNOB - AUBURN</b>				
SCHLAGE (SC1) KEYWAY	5-Pin	<b>YSC1CYL-ABNKNB</b>		<b>\$9.00</b> ea.
KWIKSET (KW1) KEYWAY	5-Pin	<b>YKW1CYL-ABNKNB</b>		<b>\$9.00</b> ea.
WEISER (WR5) KEYWAY	5-Pin	<b>YWR5CYL-ABNKNB</b>		<b>\$9.00</b> ea.

### CONSTRUCTION KEYING

#### Lost Ball System

- Last four pin locations drilled for lost ball application
- Master key wafers used for code variability
- Construction keys and owner keys sent separately
- Order by indicating "**Construction Keyed, House #\_**" next to applicable locks

#### Charge for Construction Keying - \$4.00 (NET)

Locks that are both construction keyed and keyed alike will be charged a total of \$6.00 (NET) per cylinder.

#### Charge for Re-Keying - \$3.00 (NET)

Locks that are keyed to code or keyed alike will be charged \$3.00 (NET) per cylinder.

- **Keying to Code - \$3.00 (NET)**

Order by indicating "**Key Code XXXXX**" next to applicable locks.

- **Keying Alike - \$3.00 (NET)**

- Order by indicating "**Keyed Alike**" next to applicable locks if only one keyed alike group is wanted.

- If ordering multiple groups (houses) indicate "**Keyed Alike House #\_**" next to applicable locks.

# TECHNICAL SPECIFICATIONS

## ENTRY SET AND DEADBOLT SPECIFICATIONS

Door Specs	2-1/8" Face Bore, 1" Edge Bore 5-1/2" Center-to-Center Door Prep 1" x 2-1/4" Radius Corner
Latch	2-3/8" or 2-3/4" Adjustable latch, Radius Corner
Door Thickness	1-3/8" to 1-3/4"
Cylinder	SC1 KW1 Optional WR5 Optional
Handing	Universal handing. Specify right-handed or left-handed for (Brunswick and Farmington) levers interior only.

ENTRY SETS	A	B	C	D
Marcel	2-1/2"	1-3/4"	5/8"	2-1/4"
Ellington	2-5/8"	1-3/4"	5/8"	2-1/8"
Everly	2-3/4"	1-1/2"	7/16"	2-3/16"
Maguire	2-7/8"	1-13/16"	1/2"	2-7/16"
DEADBOLTS	A	B	C	D
Marcel	2-7/16"	3/4"	2-7/16"	1-3/16"
Owen	2-1/2"	13/16"	2-1/2"	1-1/8"
Ellington	2-5/8"	1"	2-5/8"	1-3/8"
Everly	2-7/16"	1"	2-7/16"	1"
Maguire	2-1/2"	15/16"	2-1/2"	7/8"

### How to determine handing of doors

The handing of a door is always determined by facing the exterior of a door.

- If the hinge is on the left side of the door, the door is left handed (LH).
- If the hinge is on the right side of the door, the door is right handed (RH).

To order a handed product, specify LH or RH. Not all products are handed; only specify handing when required.

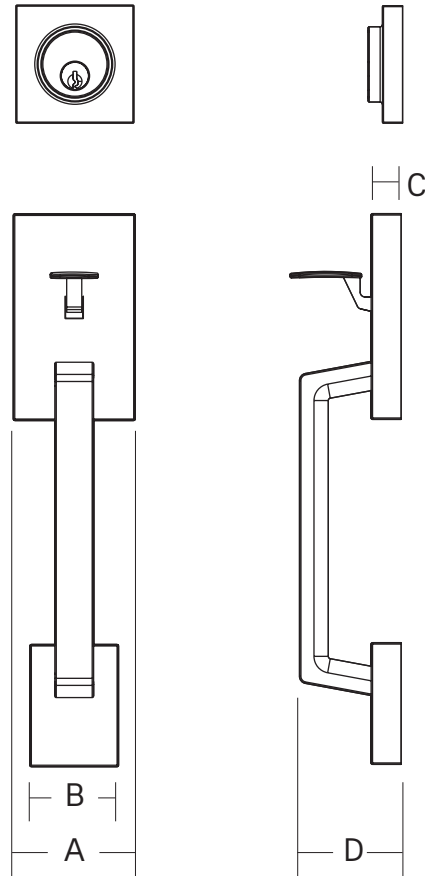
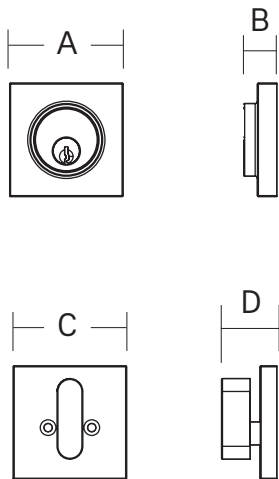
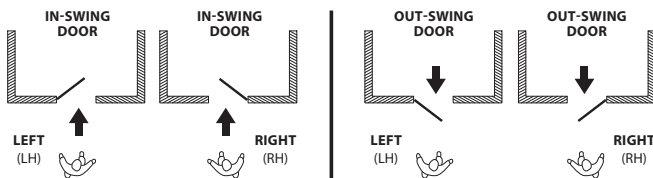

# TECHNICAL SPECIFICATIONS

## LEVER AND KNOB SPECIFICATIONS

Door Specs	2-1/8" Face Bore, 1" Edge Bore 1" x 2-1/4" Radius Corner
Latch	2-3/8" or 2-3/4" Adjustable latch, Radius Corner
Door Thickness	1-3/8" to 1-3/4"
Cylinder	SC1 KW1 Optional WR5 Optional
Handing	Universal handing

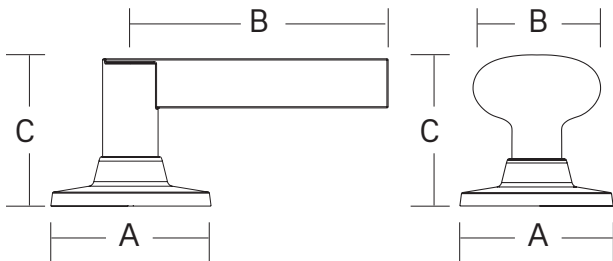

## POCKET DOOR LOCK SPECIFICATIONS

Door Specs	2-1/8" Face Bore, 1" Edge Bore 1" x 2-1/4" Radius Corner
Latch	2-3/8" Latch
Door Thickness	1-3/8"
Handing	Universal handing

LEVERS	A	B	C
Nils Lever with Marcel Rosette	2-1/2"	4"	2-1/2"
Nils Lever with Owen Rosette	2-1/2"	4"	2-1/2"
Holden Lever with Marcel Rosette	2-1/2"	4-1/8"	2-1/2"
Holden Lever with Owen Rosette	2-1/2"	4-1/8"	2-1/4"
Brunswick Lever with Ellington Rosette	2-5/8"	4-1/4"	2-3/8"
Brunswick Lever with Maguire Rosette	2-1/2"	4-1/4"	2-5/8"
Brunswick Lever with Owen Rosette	2-1/2"	4-1/4"	2-5/8"
Farmington Lever with Everly Rosette	2-5/8"	4"	2-1/2"
Farmington Lever with Maguire Rosette	2-1/2"	4"	2-1/2"

KNOBS	A	B	C
Dylan Knob with Marcel Rosette	2-1/2"	1-7/8"	2-1/2"
Dylan Knob with Owen Rosette	2-1/2"	1-7/8"	2-1/2"
Walker Knob with Ellington Rosette	2-5/8"	2-1/8"	2-1/4"
Walker Knob with Maguire Rosette	2-1/2"	2-1/8"	2-3/8"
Walker Knob with Owen Rosette	2-1/2"	2-1/8"	2-3/8"
Lewiston Knob with Everly Rosette	2-5/8"	2-1/8"	2-1/2"
Lewiston Knob with Maguire Rosette	2-1/2"	2-1/8"	2-1/2"
Auburn Knob with Everly Rosette	2-5/8"	1-3/4"	2-3/4"
Auburn Knob with Maguire Rosette	2-1/2"	1-3/4"	2-3/4"

TUBULAR POCKET DOOR LOCKS	A	B	C
Round	2-7/16"	2-7/16"	3/8"
Square	2-7/16"	2-7/16"	3/8"

## POCKET DOOR LOCKS

Square	2-1/2" x 2-3/4"
--------	-----------------

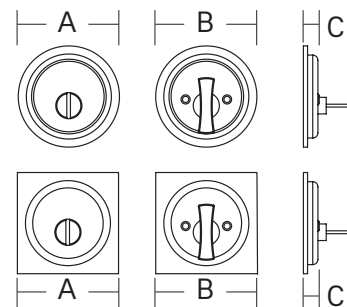

# TECHNICAL SPECIFICATIONS

## BARN DOOR HARDWARE SPECIFICATIONS

### 72" & 96" TRACKS

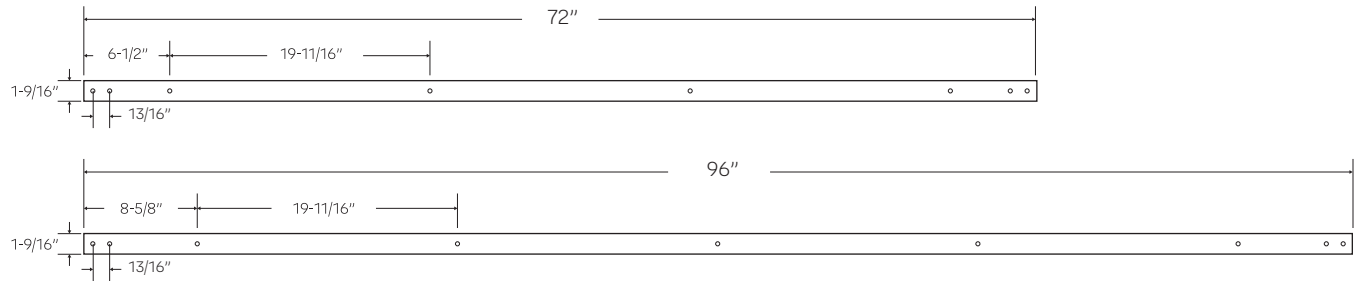

### SOFT OPEN & CLOSE WITH ACTUATOR

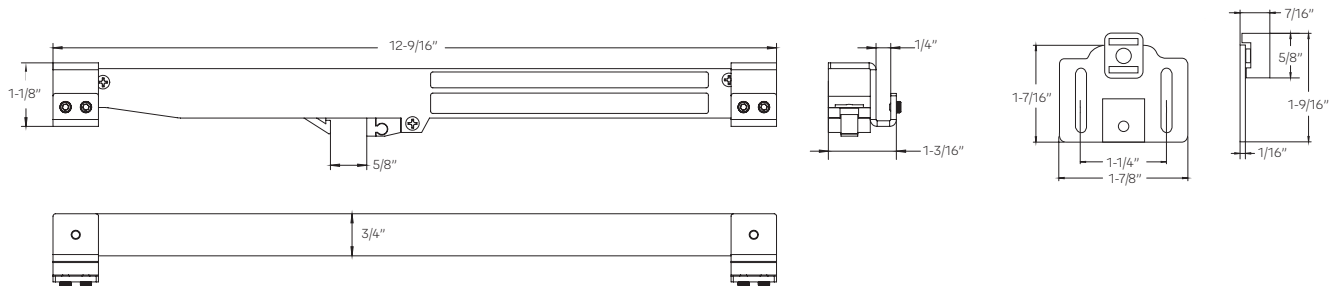

### HANGER

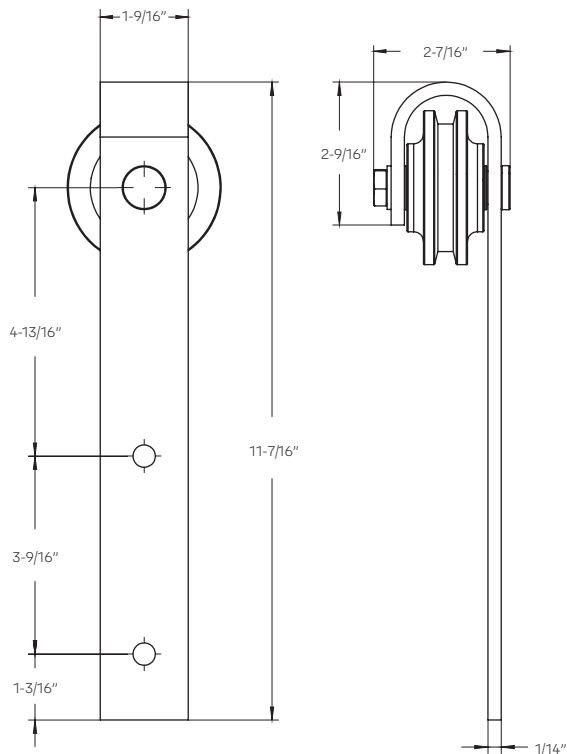

### SPACER

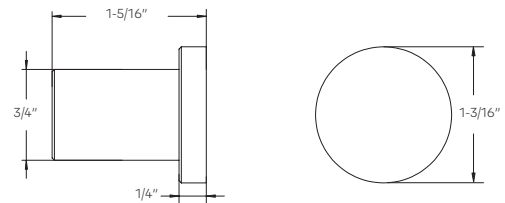

### SINGLE FLOOR GUIDE

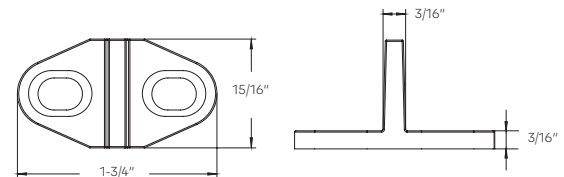

### DOUBLE FLOOR GUIDE

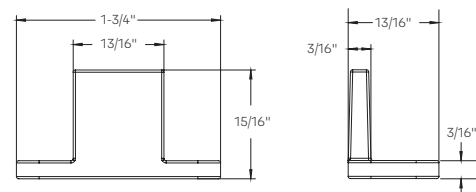

# DISPLAYS

Display Tower  
YTD.0001



- Includes: 4 Entry Sets, 2 Deadbolts, 4 Keyed Levers & Knobs, 20 Passage/Privacy/Dummy Knobsets & Lever Sets, and 3 Pocket Door Locks
- Base: 32"
- Height: 81"

Entry Set Mount Display Only  
YAKBD.9033

- Holds one Entry Set
- Base: 8" x 5"
- Height: 22-7/8"



3 Hole Mount Display Only  
YAKBD.9032

- Holds up to 3 Knobs Levers, Deadbolts
- Base: 8" x 5"
- Height: 19"



3 Hole Mount Display  
YDM.0001

- Includes one of each: Keyed, Passage, Privacy
- Base: 8" x 5"
- Height: 19"



Marcel Display  
YDM.0002

- Includes: 1 Entry Set, 4 Passage and Privacy Sets
- Base: 13" x 7"
- Height: 21-3/4"



Ellington Display  
YDM.0003

- Includes: 1 Entry Set, 4 Passage and Privacy Sets
- Base: 13" x 7"
- Height: 21-3/4"



Everly Display  
YDM.0004

- Includes: 1 Entry Set, 4 Passage and Privacy Sets
- Base: 13" x 7"
- Height: 21-3/4"



Maguire Display  
YDM.0005

- Includes: 1 Entry Set, 4 Passage and Privacy Sets
- Base: 13" x 7"
- Height: 21-3/4"



Pocket Door Display  
YDM.0006

- Includes two of each: Tubular Pocket Locks, Pocket Door Locks
- Base: 8" x 5"
- Height: 21-3/4"



Barn Door Display  
YDM.0007

- Includes: Barn Door Track, Soft Open & Close Units, 2x Hangers, Anti-Jump Discs
- Base: 21-5/8" x 10"
- Height: 21-5/8"



# YALE EXPRESSIONS™ SERIES WARRANTY

RESIDENTIAL LIMITED LIFETIME MECHANICAL AND LIMITED FIVE-YEAR FINISH

---

Subject to the terms and conditions of this warranty, EMTEK Products ("EMTEK") extends a limited lifetime mechanical warranty to the original consumer user ("Original User") of our Yale Expressions™ Series products ("Product") against mechanical defects in material and workmanship, as long as the Original User occupies the residential premises upon which the Product was originally installed. EMTEK extends a limited five-year finish warranty to the Original User of Product against tarnishing and damage as long as the Original User occupies the residential premises upon which the Product was originally installed.

**Original User:** The Original User will return the defective Product to the retailer from whom it was purchased, accompanied by a statement of defects and proof of purchase. This warranty only applies to the Original User of Products in a residential application. This warranty is not transferable.

**What EMTEK Will Do:** Upon return of the defective Product to EMTEK for inspection, free and clear of all liens and encumbrances and accompanied by the statement of defects and proof of purchase, EMTEK's sole obligation, at its option, is to either repair or replace the Product or refund the original retailer purchase price in exchange for the Product.

EMTEK MAKES NO OTHER WARRANTY OTHER THAN AS EXPRESSLY STATED HEREIN, AND ALL IMPLIED WARRANTIES, INCLUDING ANY WARRANTY OF MERCHANTABILITY OR FITNESS FOR A PARTICULAR PURPOSE, ARE HEREBY EXCLUDED.

**EMTEK'S MAXIMUM LIABILITY HEREUNDER IS LIMITED TO THE PURCHASE PRICE OF THE PRODUCT. IN NO EVENT SHALL EMTEK BE LIABLE FOR ANY CONSEQUENTIAL, INDIRECT, INCIDENTAL OR SPECIAL AND/OR PUNITIVE DAMAGES OF ANY NATURE ARISING FROM THE SALE OR USE OF THE PRODUCT, WHETHER BASED ON CONTRACT, WARRANTY, TORT, STRICT LIABILITY, PATENT INFRINGEMENT, OR OTHERWISE, EVEN IF ADVISED OF THE POSSIBILITY OF SUCH DAMAGES.** Some local laws do not allow the exclusion or limitation of incidental or consequential damages, so the above exclusion or limitation may not apply to you. This warranty gives specific legal rights and a buyer may also have other rights which may vary from state to state.

**What Is Not Covered:** The following costs, expenses, and damages are not covered by the provisions of this limited warranty: (i) labor costs including, but not limited to, costs for the removal and reinstallation of Product; (ii) shipping and freight expenses required to return Product to EMTEK.

The provisions of this warranty do not apply to Products: (i) used in commercial applications; (ii) used in common area applications; (iii) used for purposes for which they are not designed or intended; (iv) which have been subjected to alteration, abuse, misuse, negligence, or accident; (v) which have been improperly stored, installed, maintained, or operated; (vi) which have been used in violation of written instructions provided by EMTEK; (vii) which have been subjected to improper temperature, humidity, or other environmental conditions; or (viii) which, based on EMTEK's examination, do not disclose to EMTEK's satisfaction non-conformance to the warranty. Additionally, this limited lifetime warranty DOES NOT COVER scratches, abrasions, or deterioration due to the use of paints, solvents, or other chemicals.

**Warranty claims:** Please contact the retailer from whom the defective product was purchased. If assistance is needed, please contact EMTEK Customer Service at:

EMTEK Products  
Tel: 800-356-2741



**EXPRESSIONS™**  
SERIES

**Trusted every day**